

MOBOTIX c25 Hemispheric Indoor Camera



The ceiling-mounted c25 delivers two 180° panorama images of a room

Indoor Ceiling Camera. Easy To Install.

With a diameter of only 12 centimeters (< 5 inches) and a weight of approximately 200 grams, the c25 is the smallest and lightest hemispheric MOBOTIX video complete system for fast ceiling mounting in protected indoor areas. Features include a light-sensitive 5-megapixel day or night sensor and MxAnalytics. Features all functions like the traditional Q25 outdoor camera.

Technical specifications subject to change without notice. For more information on the c25 and on the entire range of MOBOTIX products, such as prices, manuals, video management software for computers and iOS devices, etc., please go to www.mobotix.com > **Products**. Or - if you would like to talk to us on the phone to get advice with our products, please call +49 06302 9816-103.

c25 Indoor Ceiling Camera: Technical Data

Model versions	Day and night version with 5-MP color or black & white sensor, incl. microphone and 4 GB microSD card: - MX-c25-D12-PW and MX-c25-N12-PW (hemispheric fisheye lens) - MX-c25-D23-PW-F1.8 and MX-c25-N23-PW-F1.8 (92° lens)
Operating conditions	Ambient temperature 0 to 40 °C (32 to 104 °F), protection class IP20 (protected from foreign bodies with diameters 12.5 mm or larger)
Designated use	Indoors • For installation in suspended ceilings
Diameter	120 mm (visible), 170 mm (with folded-out spring clips)
Depth, weight	51 mm, 212 g (camera without ETH cable)
Materials (housing)	PBT GF30
Installation diameter	105 mm
Minimum installation depth	55 mm
Clamping range	1 mm to 26 mm (possible thickness of mounting surface/ceiling panel)
Image sensor	1/2.5" CMOS sensor, 5MP (2592 x 1944), progressive scan
Minimum light sensitivity	Color sensor: 0.25 lux at 1/60 sec; 0.013 lux at 1 sec Black/white sensor: 0.05 lux at 1/60 sec; 0.0025 lux at 1 sec
Maximum image size	5MP (2592 x 1944 pixels)
Maximum frame rates MxPEG (fps)	30@HD (1280 x 720), 30@MEGA, 15@QXGA, 10@5MP
Maximum frame rates MJPEG (fps)	15@HD (1280 x 720), 12@MEGA, 6@QXGA, 4@5MP
Lens options	- L12 fisheye with f/2.0 aperture • Image angle: 180° (horizontal) x 160° (vertical) - L23 super wide-angle with f/1.8 aperture • Image angle: 92° (horiz.) x 68° (vert.)
Controls	Two buttons, two status LEDs
Sound	Microphone, 16-bit/16 kHz (HD voice)
Image processing	MxLEO, backlight compensation, automatic white balance, image distortion correction, panorama correction
Image formats	Freely configurable format 4:3/8:3/16:9 • User-defined formats (image cropping, e.g., 5 MP, QXGA, full HD, MEGA)
Multi-streaming	Yes
PTZ	Digital pan/tilt/zoom, continuous 8x zoom
Intelligent video analysis	MxAnalytics (heat maps and counting corridor reports), MxActivitySensor, video motion analysis
DVR	Via integrated MicroSD card • Externally on USB device • Externally on NAS (max. of 4 TB) • Separate live image feed and full image recording • MxFFS with archiving function • Pre- and post-alarm images • Automatic DVR surveillance including error notification
Alarm/event management	MxActivitySensor • Video motion analysis • Temperature sensor • Microphone sensor • Shock detector • Illumination sensor • Further sensors/IO via additional devices • Alarm notification via e-mail, FTP, VoIP
Video telephone	SIP client (c25 with audio extension)
Security	User/group management, SSL connection, IP address filter, IEEE 802.1x, intrusion detection, digital image signature, tamper detection
Protocols	IPv4, IPv6, HTTP, HTTPS, FTP, RTP, UDP, TCP, SNMP, SMTP, DHCP (client or server), NTP (client or server)
Interfaces	Ethernet (MxRJ45), MiniUSB • With optional MxBus/IO board with two additional signal outputs (available soon)

c25 Indoor Ceiling Camera: Technical Data	
Power supply	PoE (IEEE 802.3af, class 2), typical power consumption of 4 W
Certifications	EMC (EN 55022, CISPR 22, EN 55024, EN 61000-6-1/2) • Further standards (FCC part 15 subpart B, CFR 47, AS/NZS 3548)
(Integrated) software functions	Digital zoom • Programmable exposure windows • Snapshot recording • Full feature recording (MxFFS archive, continuous recording, full image recording including sound) • Time and event control • Time tables including holidays • Web functions • Logo generator • Flexible event logic • Master/slave arming • Multiple time-controlled privacy zones • Remote alarm notification • Programming interface/HTTP API
MOBOTIX Video Management Software (VMS) available free of charge	MxManagementCenter (MxMC), MxControlCenter (MxCC), MxEasy, MOBOTIX App
Accessories	- MX-Bus-IO-Module with two signal inputs/two signal outputs - c25 on-wall mounting set

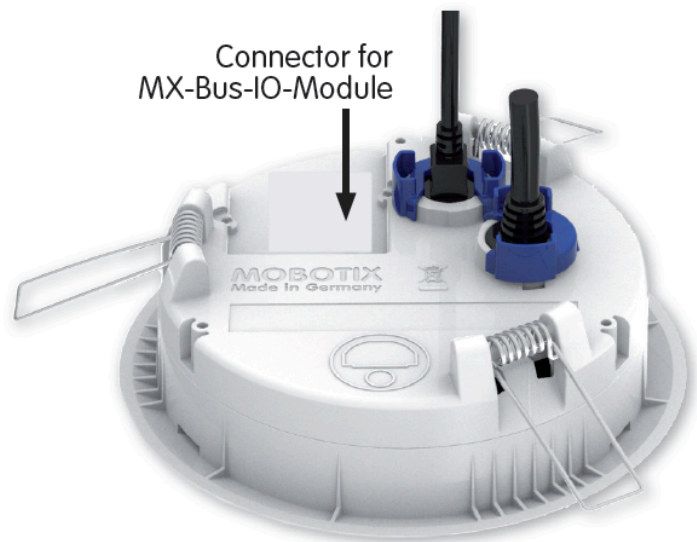
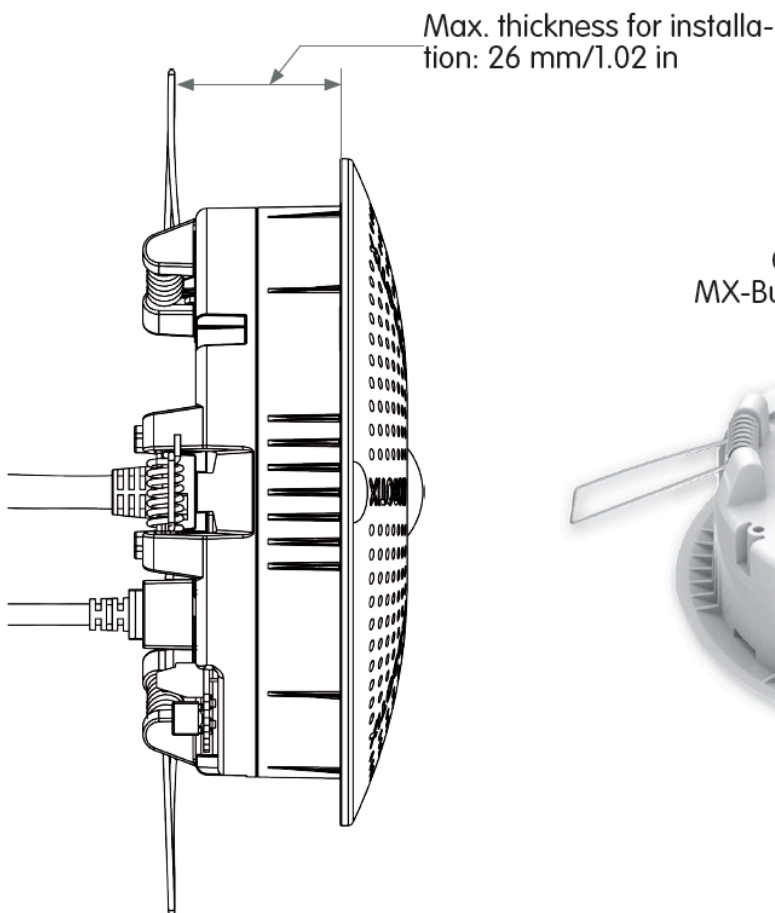

Camera Variants	c25 Day	c25 Night
Lenses, Sensors		
Hemispheric 12 mm (180° x 160°)	L12	L12
Super Wide-Angle 23 mm (92° x 68°)	L23	L23
Wide-Angle 38 mm (55° x 41°)	–	–
Wide-Angle 51 mm (40° x 30°)	–	–
Tele 76 mm (27° x 20°)	–	–
Tele 160 mm (13° x 10°)	–	–
Tele 320 mm (7° x 5°)	–	–
CSVario 28 – 63 mm (28° – 58°)	–	–
Image sensor with individual exposure zones	Color	B/W
Sensor sensitivity in lux at 1/60 s /1 s	0.25/0.013	0.05/0.0025
Image sensor resolution (color or B/W sensor)	5MP (2592 x 1944)	5MP (2592 x 1944)

Hardware Functions		
Protection class	IP20	IP20
Temperature range 0 to 40°C/32 to 104°F	•	•
Temporary internal DVR	64 MB	64 MB
Internal DVR, ex works	4 GB (MicroSD)	4 GB (MicroSD)
Microphone/speaker	•/optional via ExtIO	•/optional via ExtIO
Passive infrared sensor (PIR)	–	–
Integrated temperature sensor	•	•
Shock detector	•	•
Power consumption (typical)	4 watts	4 watts
Variable PoE class (factory default: 3)	2 or 3	2 or 3

Image Formats, Frame Rates, Image Storage		
Maximum image format (per sensor)	5MP (2592 x 1944)	5MP (2592 x 1944)
Maximum frame rate (MxPEG, max. resolution)	10 fps (5MP)	10 fps (5MP)
CIF images with 4 GB MicroSD DVR	250,000	250,000
VGA images with 4 GB MicroSD DVR	125,000	125,000
HD images with 4 GB MicroSD DVR	40,000	40,000
QXGA images with 4 GB MicroSD DVR	20,000	20,000

- available ex works
- not available

Camera Variants	c25 Day	c25 Night
General Functions		
Digital zoom (continuous) with panning	•	•
Codecs: Motion-JPEG/MxPEG/H.264 for SIP	•/•/•	•/•/•
Programmable exposure zones	•	•
Snapshot recording (pre/post-alarm images)	50	50
Terabyte ring buffer storage (internal/network)	•	•
Continuous recording with sound (0.2 to 30 fps)	•	•
Event recording with sound	•	•
Time and event control/flexible event logic	•/•	•/•
Weekly schedules/holidays	•	•
Web functionality (FTP, email)	•	•
Playback/QuadView and MultiView	•/•	•/•
Bidirectional sound in browser (e. g., via ExtIO)	•	•
Logo generator, animated	•	•
Master/Slave arming	•	•
Several scheduled privacy zones	•	•
Customized voice messages (e. g., via ExtIO)	•	•
VoIP telephony (audio/video, alert – e. g., via ExtIO)	•	•
Remote alarm notification (network message)	•	•
Signal inputs/outputs and MxBus via	MX-Bus-IO-Module	MX-Bus-IO-Module
Programming interface (HTTP API)	•	•
Security Features (HTTPS/SL, IP-based access control, IEEE 802.1X network authentication)	•	•
Video Analysis		
Video motion	•	•
MxAnalytics	•	•
MxActivitySensor	•	•
Video Management Software		
MxManagementCenter/MxControlCenter/MxEasy	•/•/•	•/•/•
MOBOTIX App (iOS)	•	•

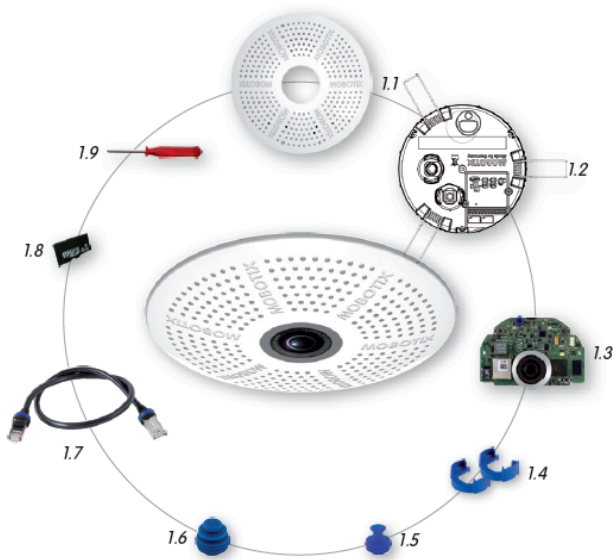

Item	Count	Part Name
1.1	1	Housing (installed)
1.2	1	Back plate with spring clips (installed)
1.3	1	Main board with lens L12 or L23 (installed)
1.4	2	Bayonet catch, blue (installed)
1.5	1	USB plug, blue (installed)
1.6	1	Ethernet plug, blue (installed)
1.7	1	Ethernet patch cable, 50 cm/19.7 in, black
1.8	1	MicroSD card (SDXC, installed)
1.9	1	Disassembly tool

(Standard delivery from the technical documentation: www.mobotix.com > Support > Manuals)

Top

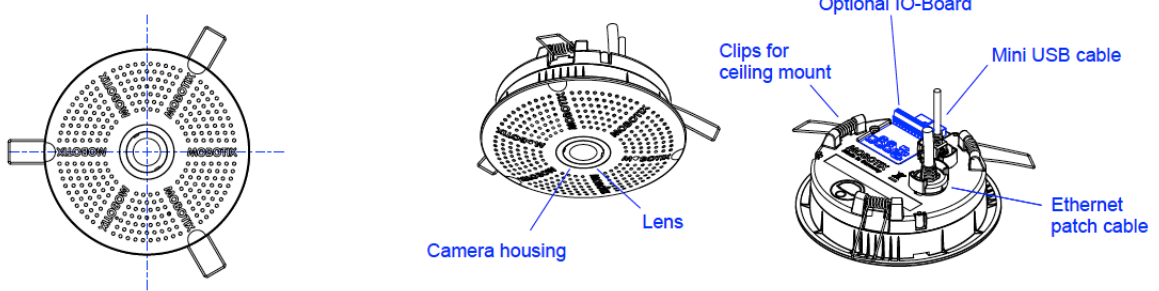

Side

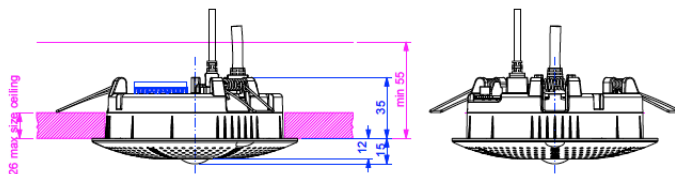

Back

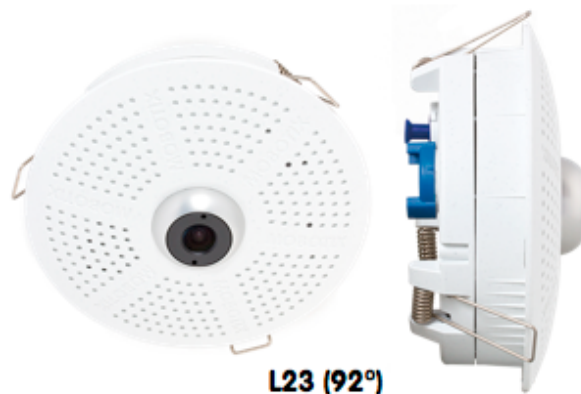
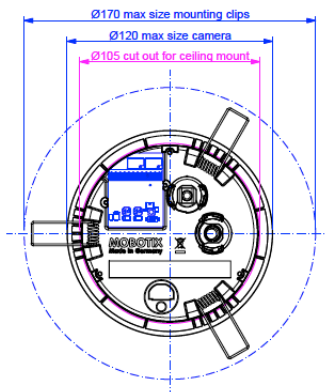

(Excerpt from technical drawings and 3D views: www.mobotix.com > Support > Image Database)

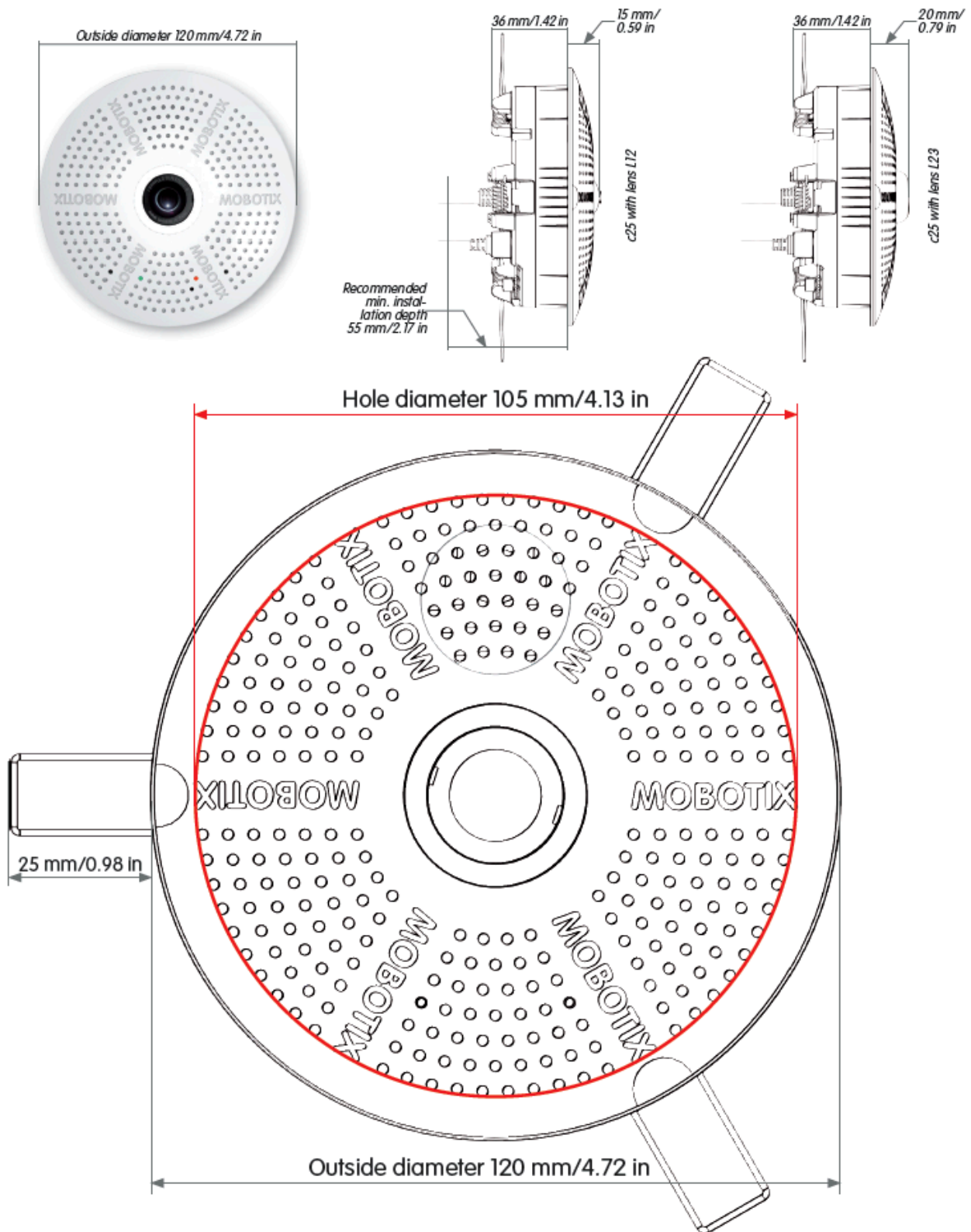

(Excerpt from the technical documentation www.mobotix.com > Support > Manuals)